

TECHNICAL DATA

Dimensions

Exterior Dimensions (WxDxH)	64.5" x 26.5" x 34"
Interior Dimensions (WxDxH)	60.5" x 20" x 25.5"
Net Volume (cu. ft.)	18 cu. ft.
Gross Weight	254 lbs
Packaging Dimensions (WxDxH)	69.5" x 32.5" x 42.5"
Electrical Cord Length	98.5"
Cases of Beer	24

Cooling

Temperature Range	33° - 40° F
Refrigerant	R290
Maximum Ambient Temperature Rating	90° F
Defrosting	Automatic
Cooling System	Ventilated
Temperature Display	No
Temperature Controller	Mechanical
H/P	1/3

Construction

Exterior Material	Painted Steel
Insulation Material	Foamed in place polyurethane
Shelf Material	Plastic coated steel
Shelf Load Capacity	132 lbs

Electrical

Voltage	115
Amps	8.5
Hz	60

PLAN VIEW



COMPLIES WITH ANSI/NSF 7 FOR FOOD SERVICE

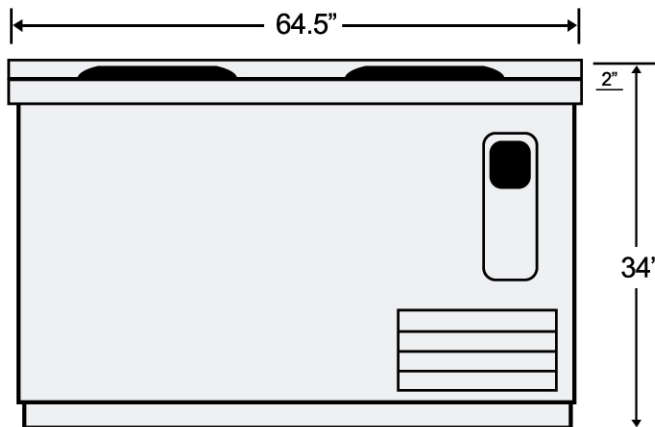

Front View

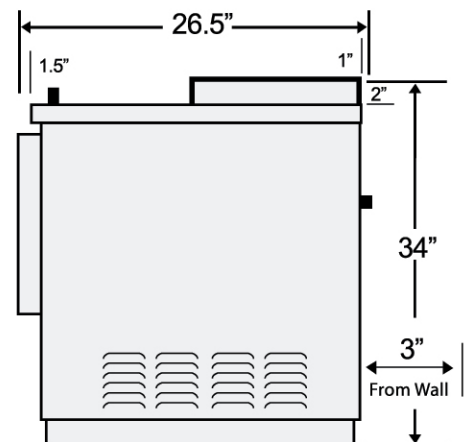

Side View

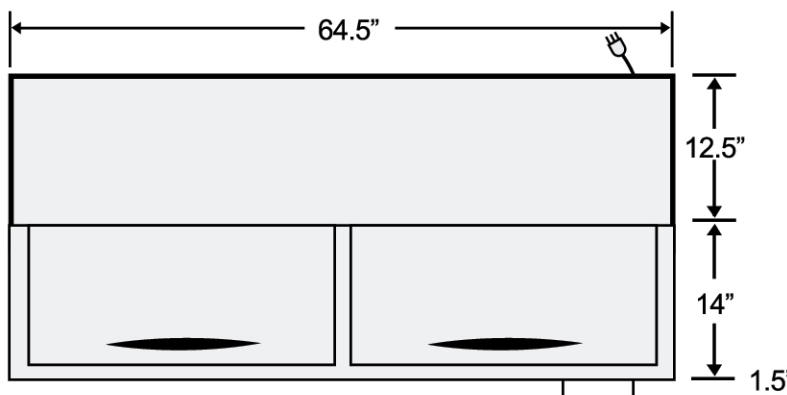

Top View

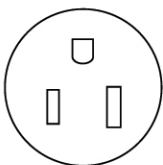

NEMA 5-15

SBC-65

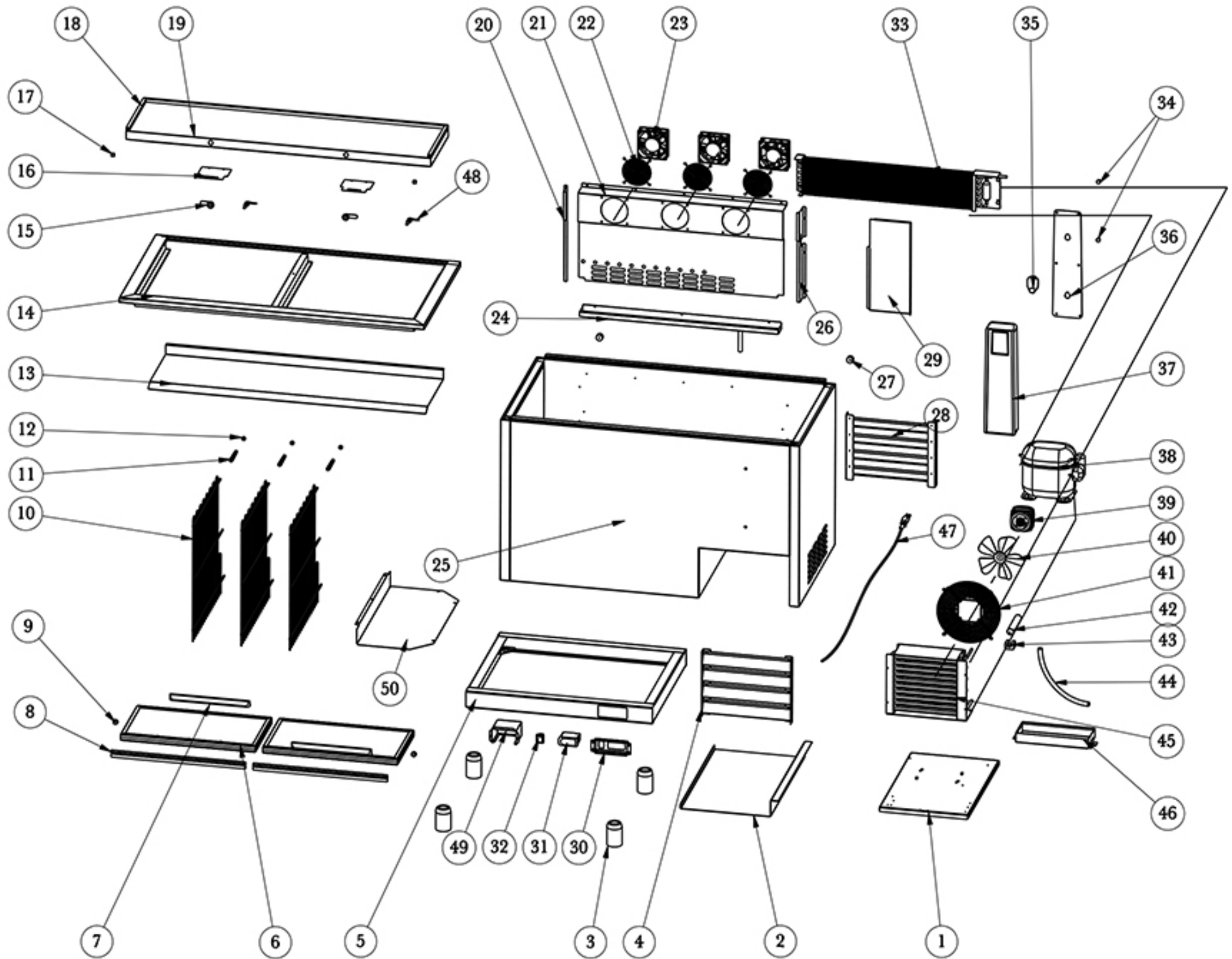

NO.	Part Name	Factory Part NO.	QTY
1	COMPRESSOR UNIT INSTALLATION BOARD		1
2	BASE BOARD		1
3	LEVELING FEET	12534030002	5
4	FRONT GRILL		1
5	CABINET BASE		1
6	DOOR		2
7	DOOR HANDLE	16337030002	2
8	DOOR GASKET		2
9	DOOR LIMIT BLOCK		2
10	SHELF	12502015555	3
11	SHELF SPRING	12556010001	3
12	SHELF CAP	16353030001	51
13	PANEL UNDER TABLE		1
14	UNDER TABLE COMPONENT		1
15	LOCK	12546100952	2
16	BASE BOARD FOR LOCK		2
17	DECORATION COVER	16351040001	2
18	DECORATION STRIP		1
19	TOP BOARD		2
20	LEFT SUPPORT FOR EVAPORATOR COVER		1
21	EVAPORATOR COVER		1
22	EVAPORATOR FAN MOTOR COVER	12504050115	3
23	EVAPORATOR FAN MOTOR	1003001114715	3
24	INNER DRAIN PAN		1
25	CABINET		1
26	RIGHT SUPPORT FOR EVAPORATOR COVER		1
27	BACK LIMIT BLOCK	16363120001	2
28	BACK GRILL		1
29	INNER BAFFLE		1
30	THERMOSTAT INSTALLATION COVER		1
31	THERMOSTAT	17505180005	1
32	POWER SWITCH	17749211297	1
33	EVAPORATOR	17402060950	1
34	SCREW FOR BOTTLE OPENER COMPONENT	12408096010	2
35	BOTTLE OPENER	16342420050	1
36	BOTTLE OPERER BOARD		1
37	BOTTLE OPENER COVER	16342420001	1
38	COMPRESSOR	17202163113	1
39	CONDENSER FAN MOTOR	22752520004	1

40	CONDENSER FAN BLADE	16381738122	1
41	CONDENSER FAN MOTOR COVER	22726010003	1
42	FILTER	17111250198	1
43	FILTER FIXER	16369690257	1
44	DRAIN TUBE	15818180020	1
45	CONDENSER	17303100261	1
46	OUTER DRAIN PAN	16316130006	1
47	POWER CORD	17664640051	1
48	KEY	12546310002	2
49	THERMOSTAT WATER PROOF COVER	16351170004	1
50	THERMOSTAT BAFFLE		1