

Delta® HT-E-SEER-T

High Temperature Sanitizing Glasswasher
with Steam Elimination & Energy Recovery

Standard Features

- ▶ Steam Elimination
- ▶ Energy Recovery System collects the hot water vapor inside the machine and uses it to preheat the incoming rinse water
- ▶ Operates on a single cold water connection
- ▶ Soft Start helps protect glassware from chipping and breaking
- ▶ 14" (356 mm) tall stand allows for storage of chemicals beneath the machine
- ▶ Energy Saver Mode
- ▶ Door interlock
- ▶ Pressure regulator and water hammer arrestor
- ▶ Recirculating wash design with fresh water rinse
- ▶ Built-in booster heater with Sani-Sure™ final rinse system ensures proper rinse temperature
- ▶ Solid-state controls with three selectable timed cycles for warewashing flexibility and performance
- ▶ Digital LED temperature/operator display
- ▶ Onboard service diagnostics
- ▶ Automatic tank fill with push button start
- ▶ Delime cycle
- ▶ Automatic pumped drain for floor and wall drain installations
- ▶ Built-in chemical pumps and priming switches
- ▶ Stainless steel wash pump
- ▶ Above-water scrap basket
- ▶ Door switch
- ▶ Labyrinth-type door seal design
- ▶ Stainless steel rear dress panel
- ▶ Double-wall cabinet for quiet operation and heat retention
- ▶ Adjustable bullet feet
- ▶ Durable stainless steel construction
- ▶ One (1) each peg and combination rack included

Note:

A vent hood is not recommended above the Jackson Delta HT-E-SEER-T, as it does not produce excessive vapors. *Always check with the local building code to know what type of ventilation is required for commercial dishmachine installations in your area.*



TALL/FREESTANDING

Specification Statement

Specified unit will be a Jackson Delta HT-E-SEER-T high temperature sanitizing door-type glasswasher, rated to NSF/ANSI Standard 3 by ETL Sanitation and operates on only a 3/4" cold water supply. Unit will be ENERGY STAR® certified and will include SEER, steam elimination and energy recovery. Unit to be rated for 24 racks per hour, 0.60 gallons per rack, and will include a 70 °F rise booster heater with Sani-Sure™ final rinse system, Energy Saver Mode, three (3) selectable timed cycles, and solid-state controls with digital LED temperature/operator display. Other features include Soft Start to protect glassware from chipping and breakage, detergent and rinse aid pumps and priming switches, automatic tank fill, above-water scrap basket, delime cycle, 3/4 HP stainless steel wash pump motor, pumped drain, pressure regulator, water hammer arrestor, door interlock switch, labyrinth-style door seal, and double-wall cabinet. 18" stand with adjustable bullet feet and dishmachine are constructed of durable stainless steel.

1-year parts and labor warranty.

Options & Accessories

- ▶ Drain Water Tempering Kit
- ▶ Scale Prevention System (SPS)
- ▶ Replacement Cartridge for SPS
- ▶ 36-Compartment Rack
 - 4-1/8" tall (105 mm)
 - 5-5/8" tall (143 mm)
 - 7" tall (178 mm)
- ▶ Combination Rack
- ▶ Peg Rack

SEER

STEAM ELIMINATION AND ENERGY RECOVERY

Fan extracts the hot water vapor from the chamber

Vapor passing over the coils inside the Heat Exchanger provides a 40 °F rise in temperature to the water inside the coils

The cooler vapor returns back into the chamber, and as the vapor condenses it is channeled into the wash tank

This process virtually eliminates the steam inside the chamber

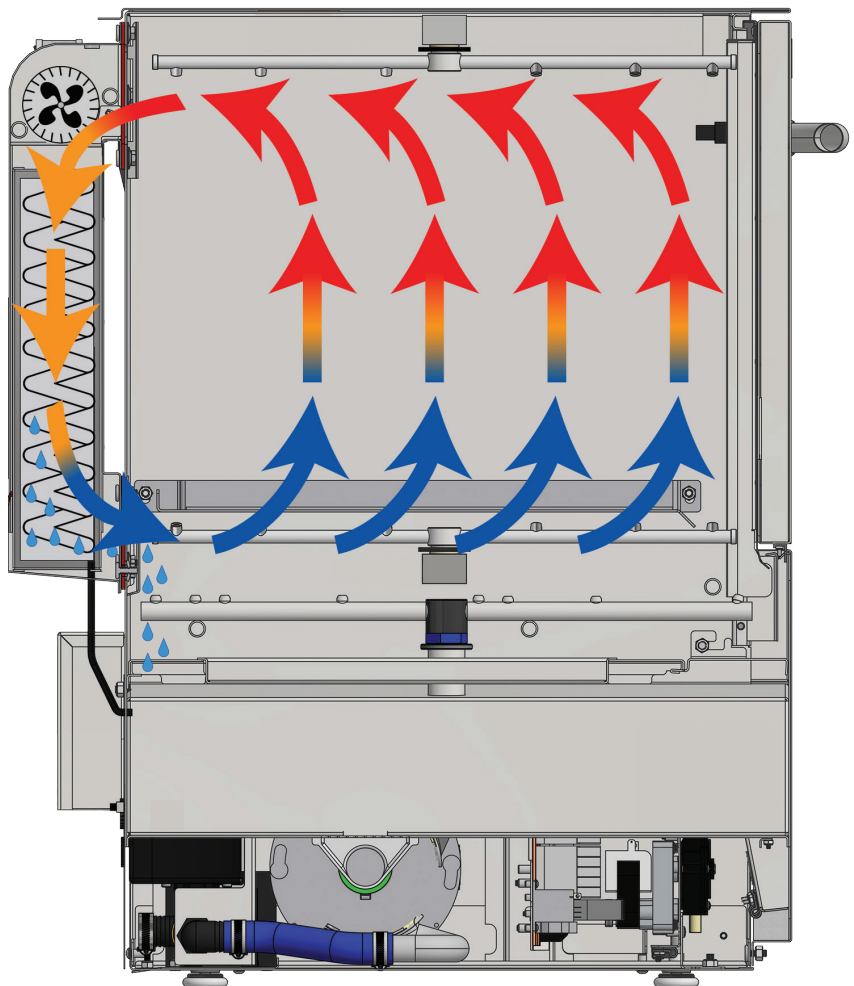

Cutaway side view of the HT-E-SEER

LEGEND

A - Electrical Connection

B - Water Inlet (with 6' Hose)
(3/4" Male GHT, connect to true
1/2" ID line, 40-90 °F)

C - Drain Connection
(5/8" ID, install into MIN
1 1/2" Drain with Air-gap)

D - Chemical Port

All dimensions from the floor
can be increased 1" using the
machine's adjustable feet.

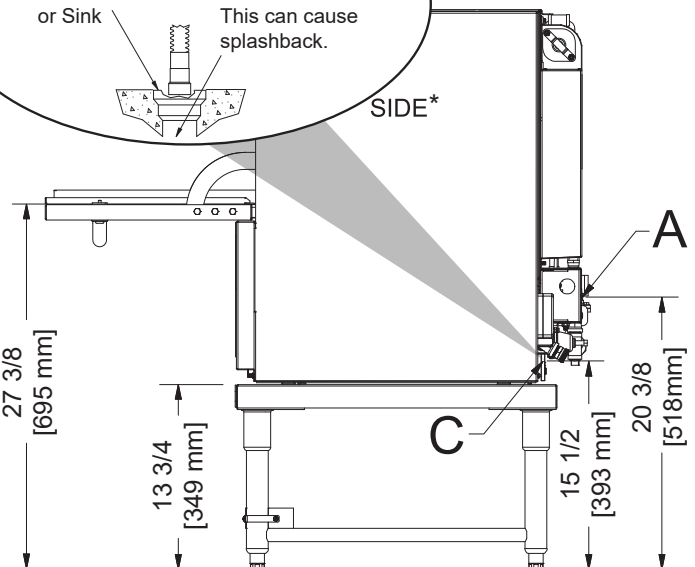
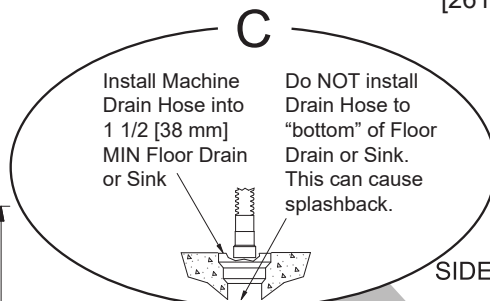
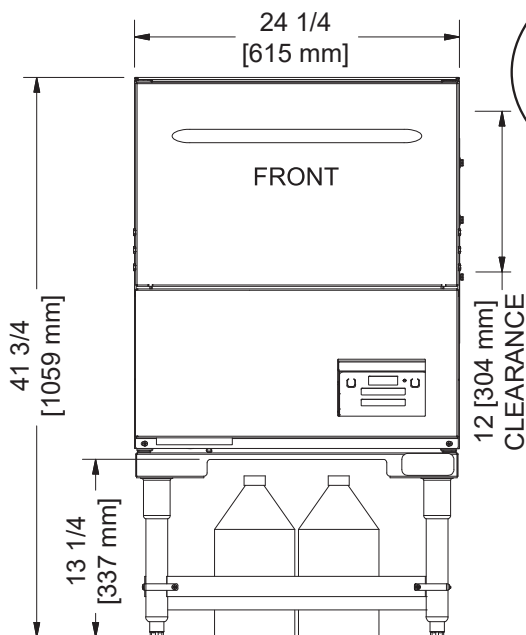
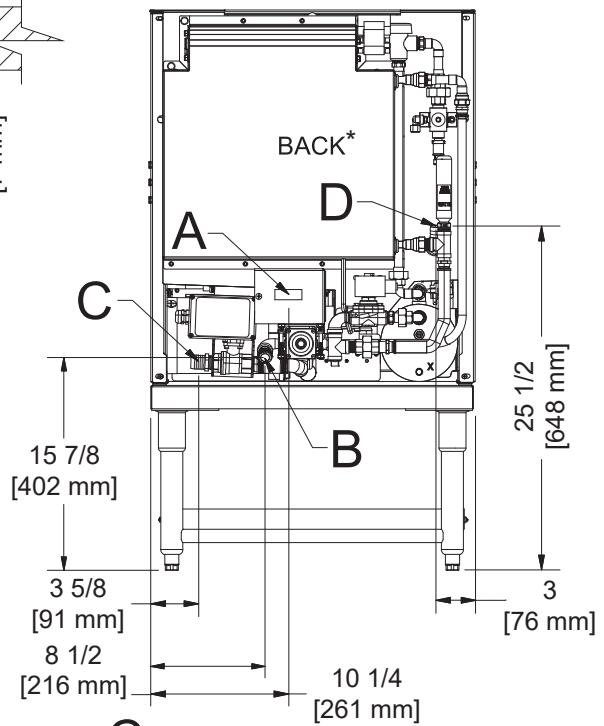
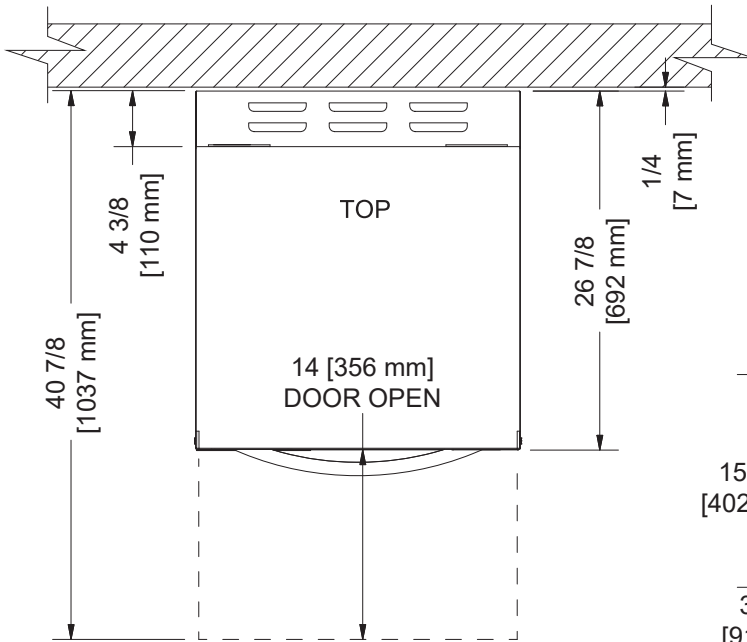

*Back and side views shown with back panel removed.



Warewashing Systems

Delta® HT-E-SEER-T

High Temperature Sanitizing Glasswasher
with Steam Elimination & Energy Recovery

Operating Capacity (Cycle I)

Racks per Hour	24 (20)*
Dishes per Hour	600
Glasses per Hour	864

Operating Temperature

Wash Temperature (minimum)	155 °F/68 °C
Rinse Temperature (minimum)	180 °F/82 °C

Operating Cycle (seconds)

	Wash	Rinse	Dwell	Vent	Total Cycle
Cycle I	80	09	11	45	145
Cycle II	148	09	11	45	213
Cycle III	248	09	11	45	313

Water Consumption

Gallons per Rack	0.60 (2.3 L)
Gallons per Hour	14.4 (54.5 L)
Gallons per Hour**	12.0 (45.4 L)
Wash Tank Capacity (gallons)	3.0 (11.4 L)
Rinse Tank Capacity (gallons)	1.66 (6.3 L)

Water Requirements

Incoming Water Temperature	40-90 °F/5-33 °C
Flow Pressure (PSI)	10
Incoming Water Connection (NPT)	3/4" Male GHT (connect to true 1/2" ID line)
Drain Connection (ID)	5/8"

Electrical Specifications

Wash Pump Motor (HP)	
208v	3/4
230v	3/4
Wash Tank Heater (kW)	
208v	3.3
230v	4.0
Rinse Tank Heater (kW)	
208v	4.1
230v	5.2

Power Supply	Total Load	Minimum Circuit Ampacity	Maximum Overcurrent Protection
208/60/1	26.3 A	27.9 A	30.0 A
230/60/1	29.2 A	30.8 A	35.0 A

Dimensions

Width	24 1/4" (615 mm)
Depth	26 7/8" (692 mm)
Depth with Door Open	40 7/8" (1037 mm)
Height	41 3/4" (1059 mm)
Inside Clearance Height	12" (304 mm)
Wall Clearance	1/4" (7 mm)
Drain Height	15 1/2" (393 mm)

Shipping Details

Shipping Weight	302 lbs (137 kg)
Shipping Width	28" (711 mm)
Shipping Depth	28 1/2" (724 mm)
Shipping Height	48 1/4" (1226 mm)
Shipping Cube	23.58 cu ft
Shipping Class	85

*Racks per hour calculated with NSF suggested load time of :30 for front opening dishmachines.

**Gallons per hour calculated with NSF suggested load time of :30 for front opening dishmachines.

Contact Jackson

07610-004-54-97 [06/12/23]

Address

6209 N U.S. Highway 25E
Gray, Kentucky 40734

Telephone & Fax

T 888.800.5672
F 606.523.1799

Email

customer.service@jacksonwws.com



JACKSONWWS.COM



JACKSON WAREWASHING SYSTEMS



JACKSON WWS

We reserve the right to change specifications in this document without incurring any obligation for equipment previously or subsequently sold.